

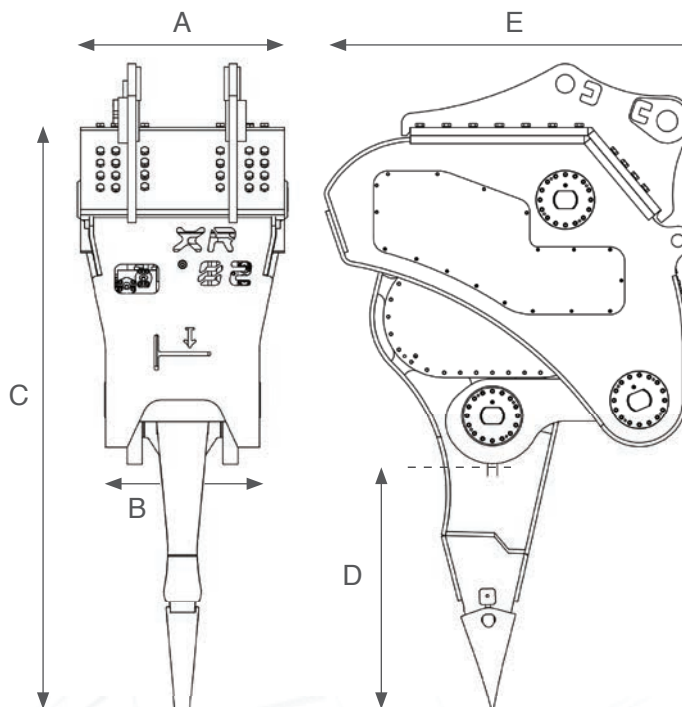

XR 42



TECHNICAL SPECIFICATIONS		XR42
Excavator weight	Tons	32 - 40
Ripper operating weight (incl. top bracket)	kg	4.640
Ripper operating weight (top bracket not included)	kg	4.120
Hydraulic working pressure	MPa	24
Hydraulic oil flow	L/min	210
Frecuency	1/min	1.100



XR42	
A	860
B	630
C	2.865
D	1.215
E	1.715

* Dimensions in millimeters.

XCENTRIC RIPPER INTERNATIONAL, S.L.

Arriurdina, 15 · 01015 Vitoria-Gasteiz (Spain) · Tel.: +34 945 290 555

www.xcentricripper.com